

HS-22L04 Hook Switch

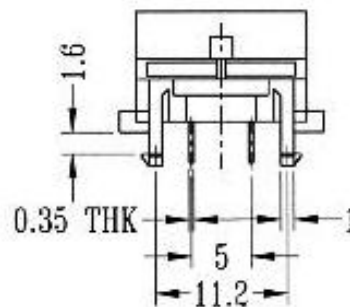

HS-22L04

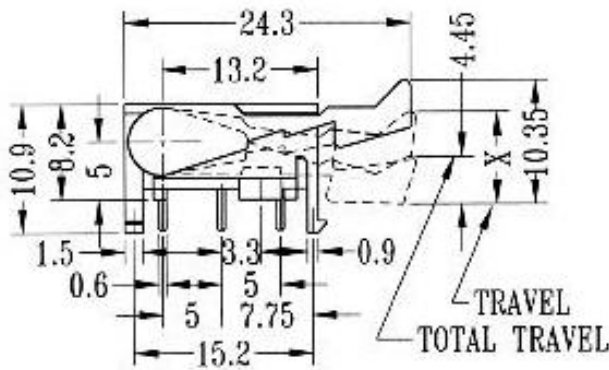
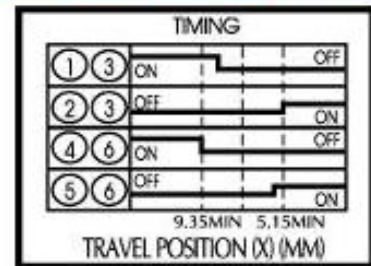
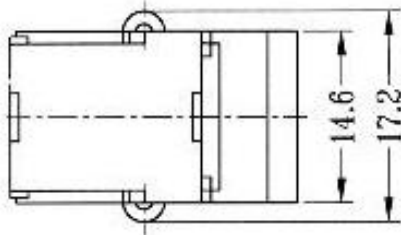

CIRCUIT DIAGRAM

SPECIFICATIONS



Function: 2P2T