

HS-32L09 Hook Switch

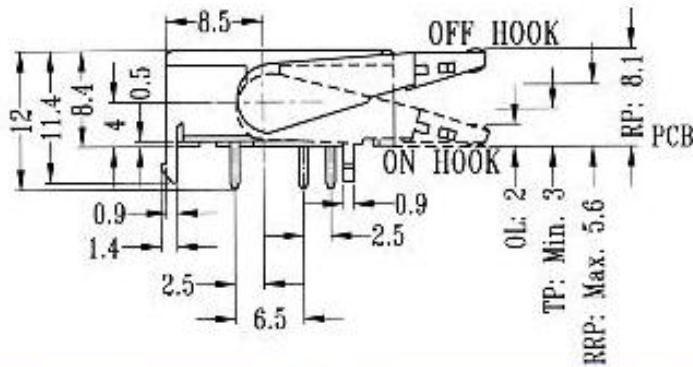

HS-32L09

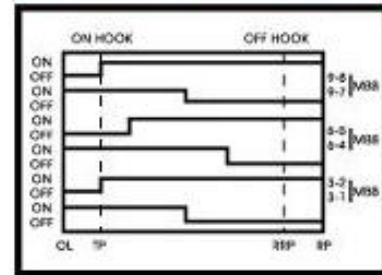
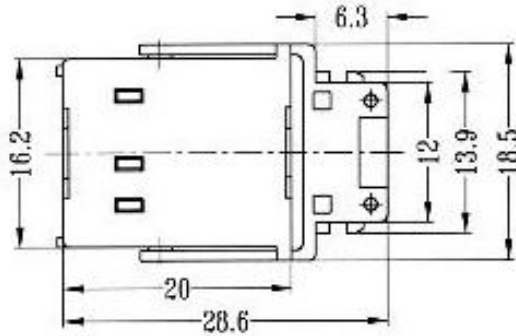

CIRCUIT DIAGRAM

SPECIFICATIONS

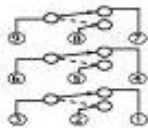

Function: 3P2T