

ET3296 Cermet Trimming Potentiometer

ELECSOUND®

Features:

Square/Multiturn/ Cermet/ Industrial/ Sealed
5 Terminal Styles
RoHS Compliant

Electrical Characteristics

Standard Resistance Range: 10Ω - 2MΩ
Resistance Tolerance: ±10% std.
Absolute Minimum Resistance: ≤1% or 2Ω
Contact Resistance Variation: ≤1% or 1Ω
Insulation Resistance : R1 ≥ 1,000 MegΩ
Withstand Voltage : 640VAC
Effective Travel: 28 turns normal

Environmental Characteristics

Power Rating:(350V max.)0.5W@70°C, 0W@150°C
Temperature Range: -55°C to +150°C
Temperature Coefficient: ±100ppm/°C
Vibration: 10-500Hz, 0.75mm, 6Hour: ΔR≤±5%
Shock: 390m/s, 4000cycles, ΔR≤±5%
Electrical Endurance:0.5W@70°C,1000H,ΔR≤10%
Rotational Life: 200Cycles,ΔR≤±5%

How to order:

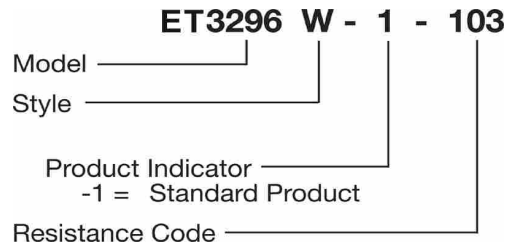

Physical Characteristics

Starting Torque: ≤35mN·m
Flammability: UL.94V-0
Marking: Resistance code, Model
Standard Packaging: 50pcs per tube

Standard Resistance Table:

Resistance (Ohms)	Resistance Code
10	100
20	200
50	500
100	101
200	201
500	501
1000	102
2000	202
5000	502
10000	103
20000	203
25000	253
50000	503
100000	104
200000	204
250000	254
500000	504
1000000	105
2000000	205

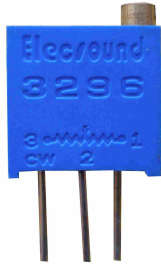

Common Dimensions

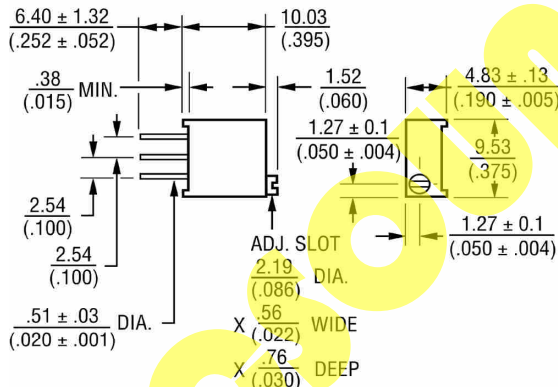

3296Y

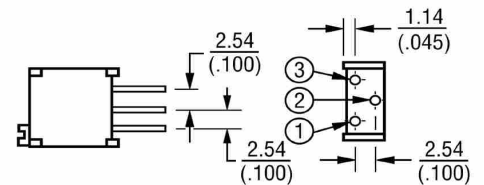

3296P

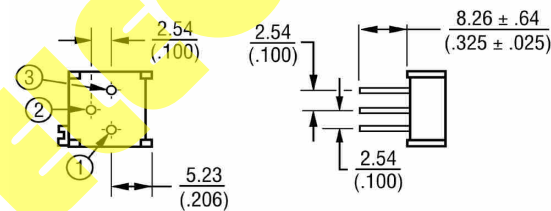

3296Z

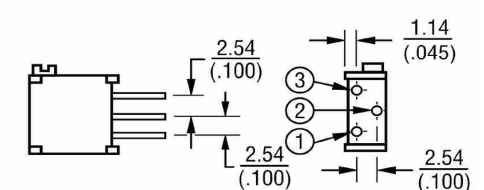

3296W

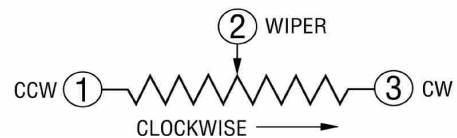
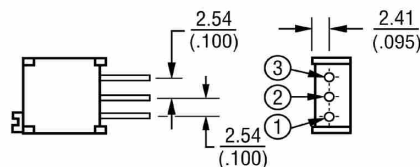

3296X

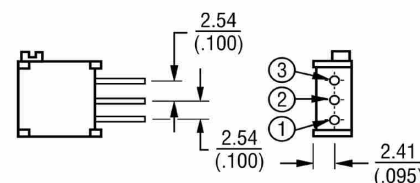

Elecsound Electronics Company Limited Copyright©2009

TEL: 86-0755-83045964 FAX: 86-0755-82948027 website: www.elecsound.com.cn

sales@elecsound.com.cn