

PS-12E05

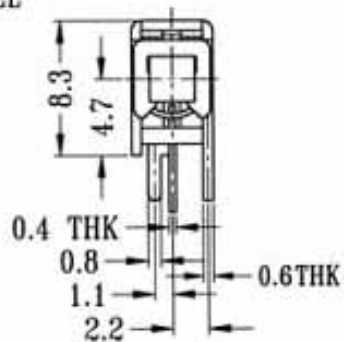

PS-12E05

(LOCKED)

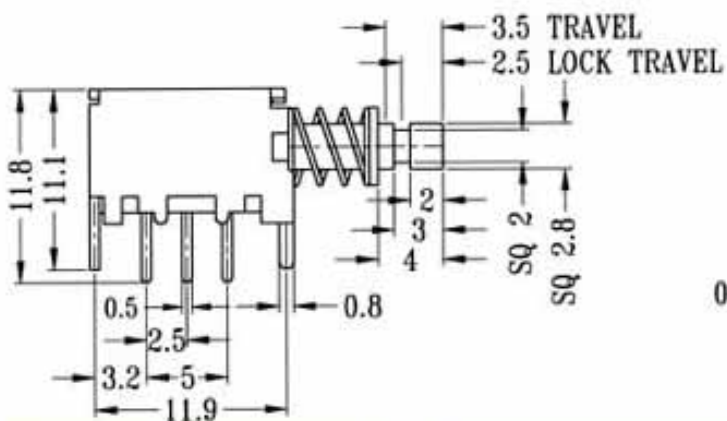
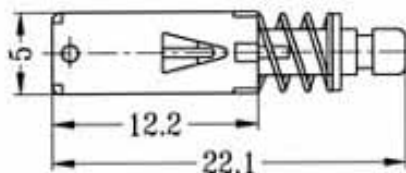

CIRCUIT DIAGRAM

SPECIFICATIONS

NON-SHORTING



Rating : 0.3A 50V DC
Function : 1P2T