

PS-22F08

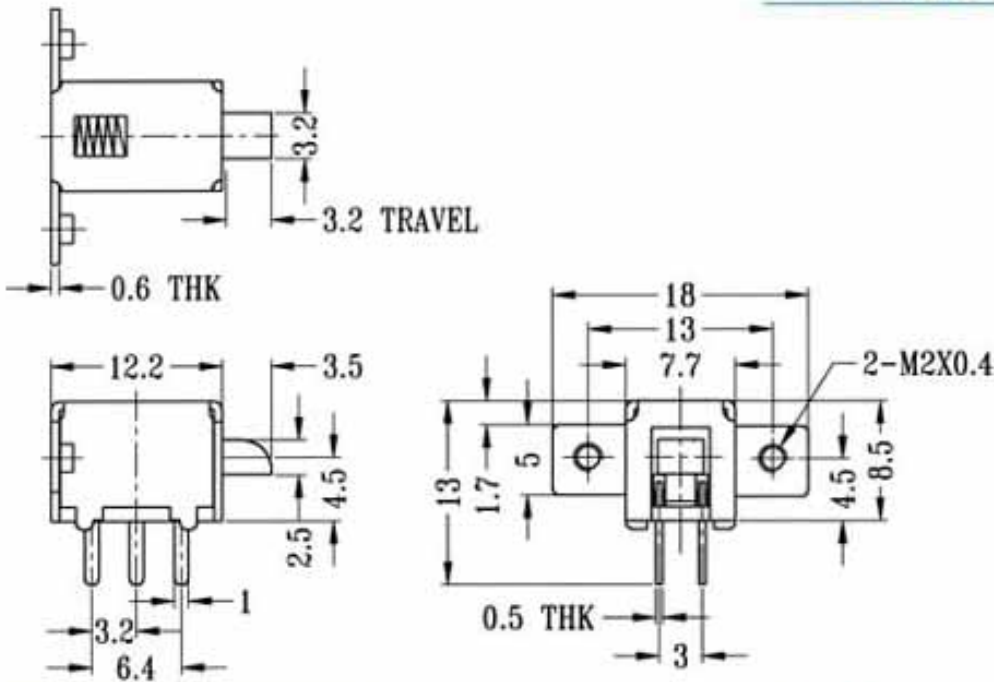

PS-22F08



CIRCUIT DIAGRAM

SPECIFICATIONS

NON-SHORTING

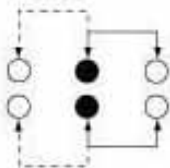

Rating : 0.3A 50V DC
Function: 2P2T