

ETC-0328 Tact Switch

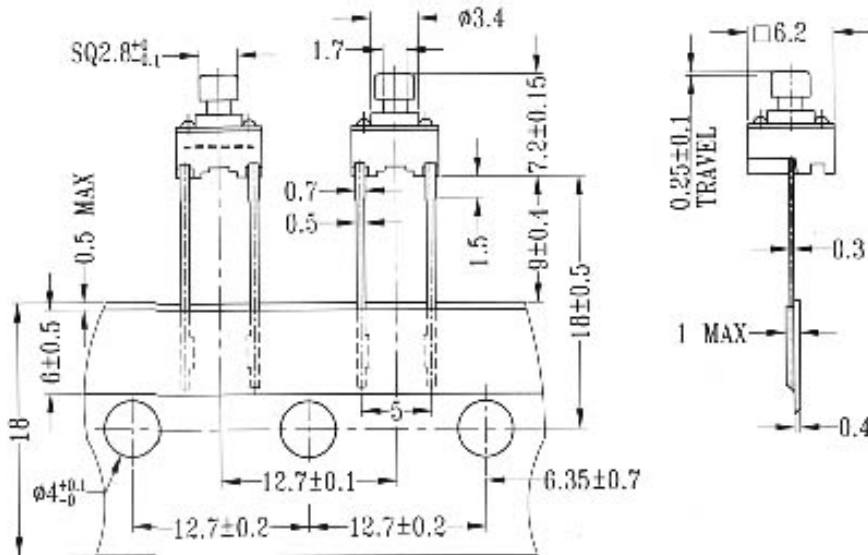

CIRCUIT DIAGRAM



SPECIFICATIONS

1. RATING : DC 12V 50mA
2. TRAVEL : 0.25 ± 0.1mm
3. CONTACT RESISTANCE 100 mΩ MAX
4. STEM DIMENSION: 2.8 x 2.8 mm

CODE	OPERATING FORCE (gf)
T	100 ± 30
V	130 ± 30
X	160 ± 50
W	170 ± 50
Y	190 ± 50
Z	250 ± 100