

ETC-0402 Tact Switch

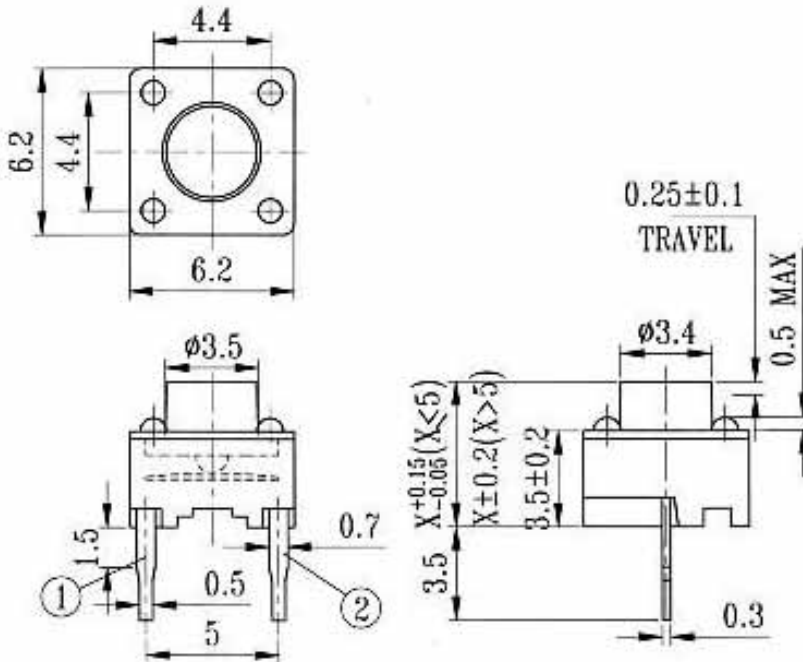

MODEL NO.	Stem Length(mm)
TC-0402	4.3
TC-0403	5
TC-0404	7
TC-0405	7.3
TC-0406	8
TC-0407	8.5
TC-0408	9.5
TC-0409	12.5

CODE	OPERATING FORCE (gf)
T	100 ± 30
V	130 ± 30
X	160 ± 50
W	170 ± 50
Y	190 ± 50
Z	250 ± 100

CIRCUIT DIAGRAM



SPECIFICATIONS

1. RATING : DC 12V 50mA
2. TRAVEL : 0.25 ± 0.1mm
3. CONTACT RESISTANCE 100 mΩ MAX